

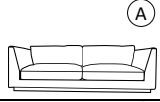

# URBAN BARN

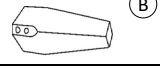



# Assembly Instructions Instructions d'assemblage

## Hartley 3S Sofa / Canapé 3S Hartley

### Components list / Liste des composantes

Picture/Image	Name/Nom	Quantity/ Quantité
 (A)	Sofa Body / Canapé	1
 (B)	Leg Patte/	4
 (C)	CenterLeg/ Patte centrale	1

### Hardware list / Liste de la quincaillerie

Picture/ Image	Name/Nom	Quantity/ Quantité
 (D)	Bolt (M8) / Écrou	8
 (E)	Flat Washer/ Rondelle plate	8
 (F)	Spring Washer/ Rondelle d'arrêt	8
 (G)	Allen key/ Clé Allen	1

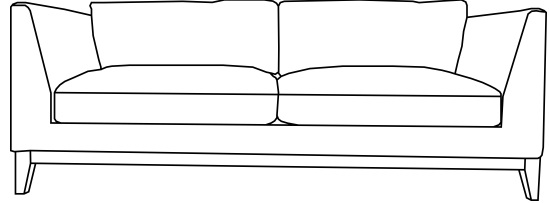

### Sofa assembly steps:

### Les étapes pour assembler le canapé:

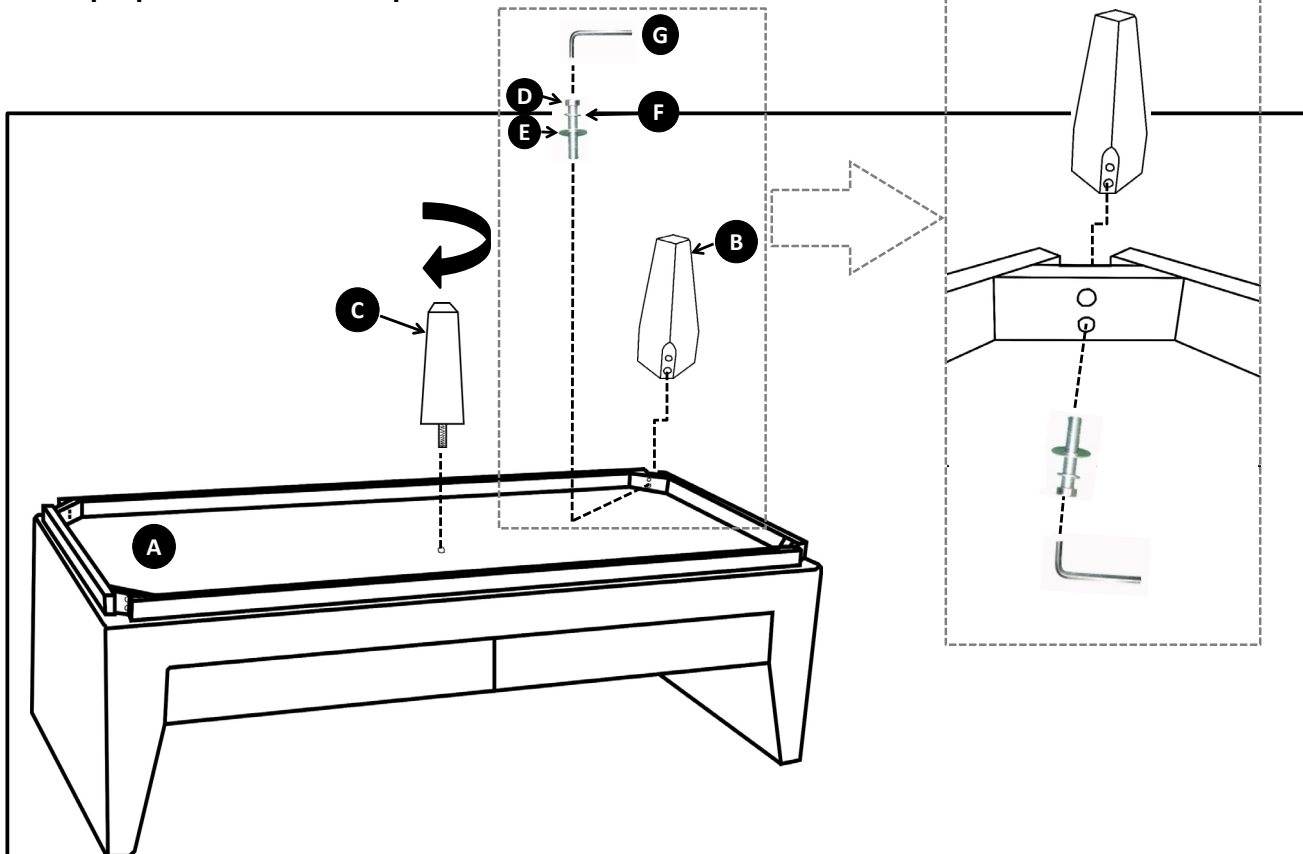

### Please Note:

1. We suggest you spend a short time reading through this leaflet and then follow the simple step by step instructions.
2. Don't discard any of the packaging until you have checked that you have all the parts and the pack of fittings.
3. Assemble this item on a carpet.
4. We strongly advise that all the fittings are only finger tightened during initial assembly only, upon completion of the assembly should all fittings points be fully tightened.
5. We strongly recommend a period check on all fixing points to make sure they remain fully tightened.
6. Keep away from direct sunlight.

### Note importante :

1. Nous vous recommandons de prendre le temps de lire ce dépliant et de suivre les instructions étape par étape.
2. Ne pas jeter les emballages avant de vous assurer que vous avez toutes les composantes et la quincaillerie.
3. Assembler le produit sur un tapis.
4. Nous vous recommandons fortement de serrer la quincaillerie avec vos doigts lors de l'assemblage initial et de resserrer tous les points d'assemblage à la fin de l'assemblage.
5. Nous vous recommandons fortement de prendre le temps de vérifier que tous les points de fixations sont bien resserrés.
6. Garder hors de la lumière directe du soleil.

